



Http://www.delta.com.tw/industrialautomation



Series Temperature Controller Instruction Sheet

Thank you very much for choosing Delta DTD series temperature controller. Please read this instruction sheet before using your DTD to ensure proper operation. Keep this instruction sheet handy for quick reference.

Warning



DANGER! CAUTION! ELECTRIC SHOCK! When the power is on, DO NOT touch the AC terminals in case an electric shock may occur. Make sure the power is disconnected when you check the input power.



DTD is an OPEN-TYPE device. If it will cause serious injury to workers or damage on other equipments when used in a dangerous environment, please make sure it is installed in an automatic safety protection device.

- Always use recommended solder-less terminals: Fork terminal with isolation (M3 screw, Max. width 7.2mm). Please be sure to tighten them properly and make sure the wire is connected to the correct terminal.
- Prevent dust or metallic debris from falling into the device and cause malfunctions. DO NOT modify or uninstall DTD series without being permitted. DO NOT use empty terminals.
- Keep away from high-voltage and high-frequency environment during installation in case of interference. Prevent using the device in premises which contain:
 - dust or corrosive gas;
 - high humidity and high radiation;
 - shock and vibration
- The power has to be switched off when wiring or changing temperature sensor.
- Make sure to use compensation wire which matches the thermocouple when extending or connecting the thermocouple wire.
- Use wires with resistance when extending or connecting the platinum resistance sensor.
- Keep the wire as short as possible when wiring a sensor to the temperature controller. Separate the power cable and load wire in order to prevent interference and induced noise.
- DTD is an open-type device. Make sure to install it in an enclosure which prevents dust and humidity in case of an electric shock.
- Make sure the power cables and signal device are installed correctly before switching on the power; otherwise serious damage may occur.
- DO NOT touch the terminals or repair the device when the power is on; otherwise an electric shock may occur
- Please wait for one minute after the power is switched off to allow the capacitor to discharge and DO NOT touch the internal wiring within this period. Use dry cloth to clean the device. DO NOT use acid or alkaline liquid to clean the device.

Display, LED & Pushbuttons



PV	Present value/function display (red 7-segment LED)
SV	Set value (green 7-segment LED)
AT	Flashes when PID auto-tuning (green LED)
OUT	On when output (green LED)
ALM	On when alarm (red LED)
	Selecting modes completing setup
	Displaying functions Left-shifting the digit
	Up key

Ordering Information

DTD 1 2 3 4 5 0

Series name	DTD: Delta D series temperature controller
1 2 3 4	4848: 1/16 DIN W48 × H48 mm 4896: 1/8 DIN W48 × H96 mm 7272: W72 × H72 mm
5	R: Relay output SPST (250VAC, 5A) V: Voltage pulse output 14V +10% ~ -20% (Max. 40mA)
Optional	0: None

Specifications

Power input	AC100 ~ 240V 50/60Hz	
Input power range	85% ~ 110%, rated voltage	
Power consumption	6VA Max.	
Display	7-segment LED; PV in red, SV in green	
Input temperature sensor	Thermocouple: K, J, T, E, N, R, S, B, U, L, Txx	Platinum resistance: Pt100, JPt100 Copper resistance: Cu50
Analog input	Current: 0 ~ 20mA, 4 ~ 20mA	Voltage: 0 ~ 5V, 0 ~ 10V, 0 ~ 70mV
Display scale	For temperature input: K2, J2, T2, Pt100-2, JPt100 and Cu50 can display to 0.1 degree; others display in 1degree as a unit.	
Control method	PID, PID programmable control, On/Off, manual output	
Control output type	Relay output: AC 250V, 5A, SPST Voltage pulse output: DC 14V, Max. output current 40mA	
Sampling cycle	0.4 second (including analog input signal and sensor input signal)	
Vibration resistance	10 ~ 55Hz 10m/s ² 3 axes 10mins	
Shock resistance	Max. 300m/s ² 3 axes 6 directions, 3 times each	
Ambient temperature	0°C ~ 50°C	

Storage temperature	-20°C ~ +65°C
Operation altitude	Less than 2,000m
Ambient humidity	35% ~ 85% RH (non-condensing)
Panel protection level	IP65

■ Operation Instructions on Keys

► Switching Modes

DTD is in operation mode (the first level) when the power is switched on. Press **SET** once to switch to the regulation mode (the second level), or press **SET** for more than 3 seconds in operation mode to switch to the initial setting mode (the third level). Press **SET** once in other screens to return to the operation mode.

► Switching Functions

Press **↶** in each mode to select functions. Press **↶** once to switch to the next function, or return to the first function when press **↶** in the last function.

► Modifying Settings

Select the item to be set up by using **SET** and **↶**. Next, press **↶**. If the item to be set up is a value, the last digit of the SV will flash. If you press **↶** to select parameters, the SV will flash. Press **↶** to increase the value of the digit or select parameters. When setting up the value, press **↶** to left shift to the digit to be modified.

► Examples

1. DTD from STOP to RUN: Press **↶** once and select parameter **r-S**. SV will display **Stop**. Press **↶** and **run** will flash. Press **SET** to save the setting and **run** will stop flashing.
2. Modifying SV from 80 to 120: Press **↶** and display 0080 (the last digit in right hand side 0 will flash). Press **↶** once and 8 will flash. Next, press **↶** 4 times and "2" in the display 0020 will flash. Press **↶** once and the 100s digit 0 will flash. Press **↶** once and "1" in the display 0120 will flash. Press **SET** to complete and save the setting.

■ Input Settings

► Setting up Input Type

When DTD is switched on, SV will display the type of the input sensor (default K1 = thermocouple type). Press **SET** for more than 3 seconds in the operation mode and PV will display the parameter **INPT**. Press **↶** to select the sensor types (see the table below) and press **SET** to complete and save the setting. The screen will return to the screen of operation mode.

If the setting is current input, a 249Ω resistor has to be connected to the current input terminals.

► Setting up Input Unit

In the operation mode, press **SET** for more than 3 seconds and PV will display the parameter **INPT**. Press **↶** once to select the unit. If the input type is thermocouple or platinum resistance, the PV will display **TEMP**. In this case, press **↶** to select the temperature unit (°C or °F). If the input type is an analog input, the PV will display **SP**. In this case, you can set up the position of the decimal point for the analog input. Press **SET** to complete and save the setting.

► Setting up Input Range

After you complete setting up the input unit, press **↶** once to display the parameter **EP-H**. Use **↶** and **↶** to set the maximum value for the temperature range. Press **↶** again to display the parameter **EP-L**, and use **↶** and **↶** to set the minimum value for the temperature range. The default range is the maximum range measurable (see the table below) and both parameters cannot exceed this range. When PV exceeds the range, PV will flash and DTD will stop its operation.

When in analog input, the temperature range also refers to the maximum and minimum input values. For example, when 4 ~ 20mA input is adopted, **EP-H** = 2,000, **EP-L** = 400. That is to say, PV = 1,200 refers to the input is 12mA and the unit is 0.01mA.

► Adjusting Input Inaccuracy

When there is the need to correct the measured input PV, press **SET** once in the operation mode to enter the regulation mode. Press **↶** repeatedly until the parameter of input compensation value **EPoF** appears. Modifying this parameter will make the PV = measured value + input compensation value. Press **↶** again to display the parameter of input gain **EP6n** and make PV = measured value × (1 + input gain/1,000) + input compensation value. Press **↶** again and display the parameter of software filter **FILT** (default = 2). Increase this parameter to enhance the stability of the PV; however, this will result in slow reaction to the input value.

Input Sensor Type	Display	Temperature Range
4 ~ 20mA input	AR4	-999 ~ 9,999
0 ~ 20mA input	AR0	-999 ~ 9,999
0V ~ 10V input	U10	-999 ~ 9,999

Input Sensor Type	Display	Temperature Range
0V ~ 5V input	uS	-999 ~ 9,999
0 ~ 70mV input	mv	-999 ~ 9,999
Cu50 type	Cu50	-50.0°C ~ 150.0°C (-90.0°F ~ 302.0°F)
Pt100 type 2	Pt2	-99.9°C ~ 600.0°C (-99.9°F ~ 999.9°F)
Pt100 type 1	Pt1	-200°C ~ 600°C (-360°F ~ 1,112°F)
JPt100 type	JPt	-20.0°C ~ 400.0°C (-36.0°F ~ 752.0°F)
Thermocouple TXK type	TXK	-200°C ~ 800°C (-360°F ~ 1,472°F)
Thermocouple U type	U	-200°C ~ 500°C (-360°F ~ 932°F)
Thermocouple L type	L	-200°C ~ 850°C (-360°F ~ 1,562°F)
Thermocouple B type	B	100°C ~ 1,800°C (180°F ~ 3,272°F)
Thermocouple S type	S	0°C ~ 1,700°C (0°F ~ 3,092°F)
Thermocouple R type	R	0°C ~ 1,700°C (0°F ~ 3,092°F)
Thermocouple N type	N	-200°C ~ 1,300°C (-360°F ~ 2,372°F)
Thermocouple E type	E	0°C ~ 600°C (0°F ~ 1,112°F)
Thermocouple T type 2	T2	-99.9°C ~ 400.0°C (-99.9°F ~ 752.0°F)
Thermocouple T type 1	T1	-200°C ~ 400°C (-360°F ~ 752°F)
Thermocouple J type 2	J2	-99.9°C ~ 999.9°C (-99.9°F ~ 999.9°F)
Thermocouple J type 1	J1	-200°C ~ 1,200°C (-360°F ~ 2,192°F)
Thermocouple K type 2	K2	-99.9°C ~ 999.9°C (-99.9°F ~ 999.9°F)
Thermocouple K type 1	K1	-200 °C ~ 1,300°C (-360°F ~ 2,372°F)

■ Control Settings

► Setting up Control Mode

In the operation mode, press **SET** for more than 3 seconds and PV will display the parameter **Ctrl**. Press **↶** for 4 times to display the parameter **Ctrl**. The default setting of this parameter is "On/Off control" **OnOff**. Use **▲** to select PID control **Pd**, PID programmable control **Prog** or manual control **ManU**. Press **↶** again and display the parameter **SHC** for selecting the control method. You can select heating (default) **HEAT** or cooling **COOL**. Press **SET** to return to the operation mode.

► Setting up RUN and STOP

In the operation mode, press **↶** and display parameter **r-s**. The default is RUN **run**. Use **▲** to select STOP **stop**. Press **SET** to complete the setting and the output will be disabled.

► Setting up On/Off Control Parameters

Press **SET** in the operation mode. If DTD is in On/Off heating mode, the PV will display **HtS**; if in On/Off cooling mode, the PV will display **CtS**. Modify these parameters to set up the hysteresis of On/Off. The default setting is 0 (without hysteresis). When the output reaches SV, the control output will be disabled. When the input is bigger (cooling) or smaller (heating) than the SV and hysteresis, the control output will be enabled. When the On/Off hysteresis is not 0, the control output will be like the diagrams below.

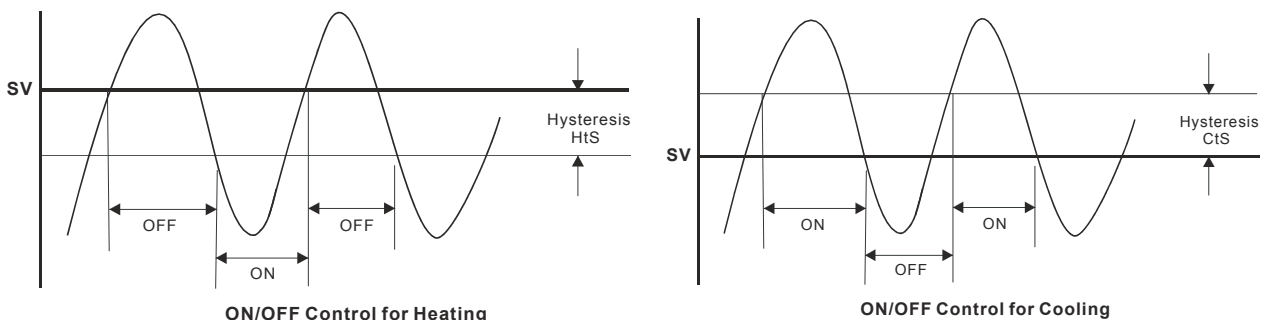

► Setting up PID Parameters

When in PID control mode, you have to first decide the On/Off cycle time for the control output, i.e. the control cycle. Press **SET** in the operation mode and PV will display **RE**. Press **↶** 5 times to display the parameters of heating control cycle **HtPd** or cooling control cycle **CtPd**. Set up the cycle depending on the reaction speed of the control system. In principle, the faster the reaction, the shorter the cycle and more accurate the control. A short control cycle indicates that there will be more times of On/Off. If you adopt relay output, the short cycle will shorten the life span of the relay. Therefore, it is recommended that you adopt voltage output in the PID control mode. The default setting of the control cycle is 20 seconds.

Parameters P, I and D can be set up manually or auto-tuned by DTD. Follow the steps below for the auto-tuning.

Press **SET** in the operation mode and PV will display the parameter **At**. In RUN state **rUn**, set the parameter to **on** and DTD will perform an auto-tuning. The AT indicator will flash and after the setup is completed, the AT indicator will be off. The PID parameters will be written in automatically and saved. To set up the parameters manually, enter the regulation mode and select the parameter **At**. Press **↶** once to display the parameter of proportion band **P**, indicating the range where P control is enabled. See the diagrams in the next page.

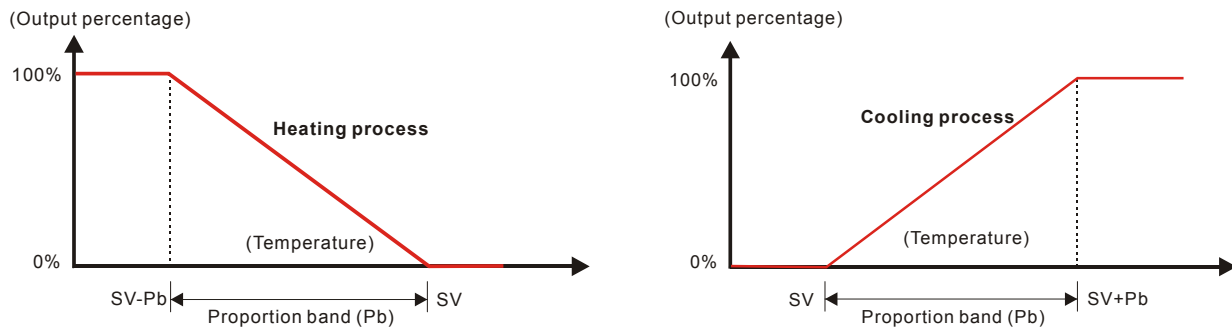

The bigger the parameter P, the less possible that the heating will exceed the SV and the longer it will take for the temperature to reach SV. This is suitable for the control system with faster reaction speed. On the contrary, the smaller the parameter P, the more possible that the heating will exceed the SV and the shorter it will take for the temperature to reach SV; however, unstable control is more likely to occur. Smaller P is suitable for the control system with slower reaction speed.

How to set up the parameter of integration time I **I**: The bigger the value I, the longer the integration time, as well as the time to reach the SV. Unstable control is also less likely to occur. On the contrary, the smaller the value I, the shorter the integration time, as well as the time to reach the SV. Unstable control is thus more likely to occur.

How to set up the parameter of differentiation time D **d**: The bigger the value D, the faster reaction speed and repression power DTD has for the external interference. However, if D is too big, the repression power that is also too big will result in out of control of the situation.

Parameters for PID control: The default integration output volume **LoF** is to allow the temperature to fast reach the SV. The parameter **Pdof** is for compensating the steady error in PD control. The two parameters are the output percentages when the input reaches the SV. Assume the output percentage is 20% when PV = SV, the best setting for this parameter is 20.0. The parameter **LoF** can be a reference value when being auto-tuned. It can also be adjusted manually.

► PID Programmable Control

PID programmable control offers 8 steps for you to plan for the temperature control program. You can set up your own number of steps and times of execution and directly monitor the current executing step, remaining time and the current SV. There is only 1 group of PID parameter settings and by the first step, you can directly control the temperature to the SV. You can also set up the control status that after the program ends, DTD will either stop the output or stay at the last SV.

Setting up the parameters in the program: To set up the parameters in the program, you have to first enter the initial setting mode and set the control mode as programmable control **Prog** to further display the parameters which you can set up.

In the operation mode, press **SET** and enter the regulation mode. PV will display the parameter of the number of steps to be executed **PSY**. Maximum 8 steps can be planned in this parameter.

After the setup is completed, press **↶** to display the parameters for setting up the execution loops **Loop**. The range of this parameter is 1 ~ 99, e.g. 2 means executing twice.

Press **↶** to setup the parameter **PEnd** for the action of DTD after the program ends. Set this parameter as **Stop**, indicating that the control output will stop after the program ends. Set this parameter as **Hold**, indicating that DTD will stay at the last step before the program ends.

Press **↶** and display the parameter of SV of step 1 **SP01**. Use **↶** and **▲** to set up the SV. Next, press **↶** to display the parameter of the executing time of step 1 **TC01**. Use **↶** and **▲** to set up the time (unit: minute; Max. 9,999 minutes). After the setup of step 1 is completed, press **↶** to set up the parameters (SV and executing time) of the next step. Please note that the number of steps is decided by the setting of the parameter **PSY**. The number of steps that exceeds the setting will not be displayed on the screen of DTD during the operation. Press **SET** to return to the operation mode and press **↶** to display the parameter **r-S**. Set this parameter as **rUn** and execute the control. DTD does not offer pause function; all executions start from step 1.

In the operation mode, on the SV display, you can monitor the present value (default) **SP**, remaining executing time **r-tc**, or the executed number of loops and steps **l-P-S**. Use **▲** to switch between different monitoring modes and press **SET** to display the selected monitoring mode. When the execution of the program ends, the remaining executing time will be displayed as "0" and the executed loops and steps as **PEnd**.

► Setting up Manual Control

Select manual control in the control mode and set up the control cycle first. Next, press **↶** repeatedly in the operation mode until **oUt** is displayed. Use **↶** and **▲** to modify the output percentage. During the execution **rUn**, the output percentage will vary upon different output percentage settings. The output setting will be saved and the saved setting will be adopted next time when DTD is switched on. The default setting is 0%.

■ Alarm Settings

► Setting up Alarm Mode

DTD offers 9 alarm modes and 4 alarm options. Press **SET** for more than 3 seconds and PV will display the parameter **OnPt**. Press **↶** for 6 times to display the parameter **ALAn** for setting up alarm modes. Use **▲** to select a desired alarm mode. Mode 9 is only available in the programmable control mode. See the table below for the explanation of every alarm mode.

Mode	Alarm Type	Alarm Output Operation
0	No alarm	Off
1	Deviation upper- and lower-limit: Alarm will be enabled when the PV exceeds SV + AL-H or falls below SV - AL-L.	
2	Deviation upper-limit: Alarm will be enabled when the PV exceeds SV + AL-H.	
3	Deviation lower-limit: Alarm will be enabled when the PV falls below SV - AL-L.	
4	Absolute value upper- and lower-limit: Alarm will be enabled when the PV exceeds AL-H or falls below AL-L.	
5	Absolute value upper-limit: Alarm will be enabled when the PV exceeds AL-H	
6	Absolute value lower limit: Alarm will be enabled when the PV falls below AL-L.	
7	Hysteresis upper-limit: Alarm will be enabled when the PV exceeds SV+AL-H and disabled when the PV falls below SV+AL-L.	
8	Hysteresis lower-limit: Alarm will be enabled when the PV falls below SV - AL-H and disabled when the PV exceeds SV - AL-L.	
9	Alarm will be enabled only during the execution of the program.	

► Setting up Alarm Option

To set up the alarm function, press **↶** after you have set up the alarm mode and the parameter **RoPt** will be displayed. Use **▲** to set up the desired option and the parameter to be set will flash. Press **▲** again to change the setting. When the parameter is flashing, you can press **↶** to move to other digits. Press **SET** to complete and save the setting. The initial setting of the alarm option is 0000, i.e. all alarm options are not enabled. If you need to enable all the alarm options, set the parameter to 1111.

Standby alarm output		Set the first digit in right hand side as 1 to enable the standby mode. The alarm output will be enabled when the PV is SV± 2 and the system is in execution.
Alarm output inversion		Set the second digit in right hand side as 1, when the alarm output is enabled, the alarm output contacts will be normally open. When there is no alarm output, the relay terminals will be short-circuit. Please be noted that the alarm indicator only relates to whether the control criteria are true and has nothing to do with the alarm output contact.
Holding alarm output		Set the second digit in left hand side as 1 to hold the alarm output. In this function, after the alarm output is enabled, the alarm will keep being enabled unless you stop Stop the operation of DTD.
Displaying alarm peak value		Set the first digit in left hand side as 1 to display the peak value. When the alarm output is enabled, DTD will be able to record the highest and lowest alarm temperature and display the two values in parameter ALHP and ALLP . Before the alarm is enabled, the parameter will be displayed as ---- . The values will not be kept after the power of DTD is switched off.

Note: DO NOT use standby alarm, holding alarm and displaying alarm peak values in alarm mode 7, 8 and 9.

► Exceptions in Alarm Functions

- When DTD is switched on, in STOP state or alarm mode 0, the alarm will not be enabled and the standby status will be cleared.
- Where there is no input sensor connected to DTD or input error, the status of the alarm output will remain.
- Modifying alarm mode will not clear the standby status. The standby alarm will only be cleared when you STOP the operation of DTD and re-RUN it again.

■ Error Display

Error Status	Initializing	No Input Sensor Connected	Input Signal Error	Exceeding Upper Limit	Exceeding Lower Limit	Exceeding Setup Range
PV						Flashing
SV				N/A	N/A	N/A
Note	Initializing. Displaying software version and the type of input sensor.	The input voltage is too big, connecting to empty terminal, or incorrect sensor.	Cannot get temperature value, ADC input error.	The displayed value exceeds 10,999.	The displayed value is smaller than -1,999.	The input exceeds TP-H (Max. temp), TP-L (Min. temp), or the range of the input sensor selected.

■ How to Mount

1. Insert DTD into the panel cutout.
2. Insert the mounting bracket into the mounting groove at the top and bottom of DTD.
3. Push the mounting bracket forward until the bracket stops at the panel wall.
4. Tighten the screw.

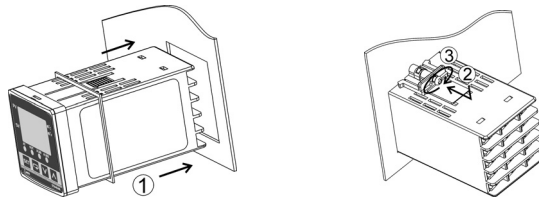

■ How to Install Mounting Bracket

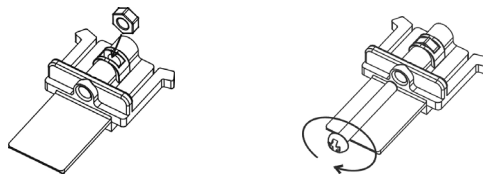

■ Panel Cutout

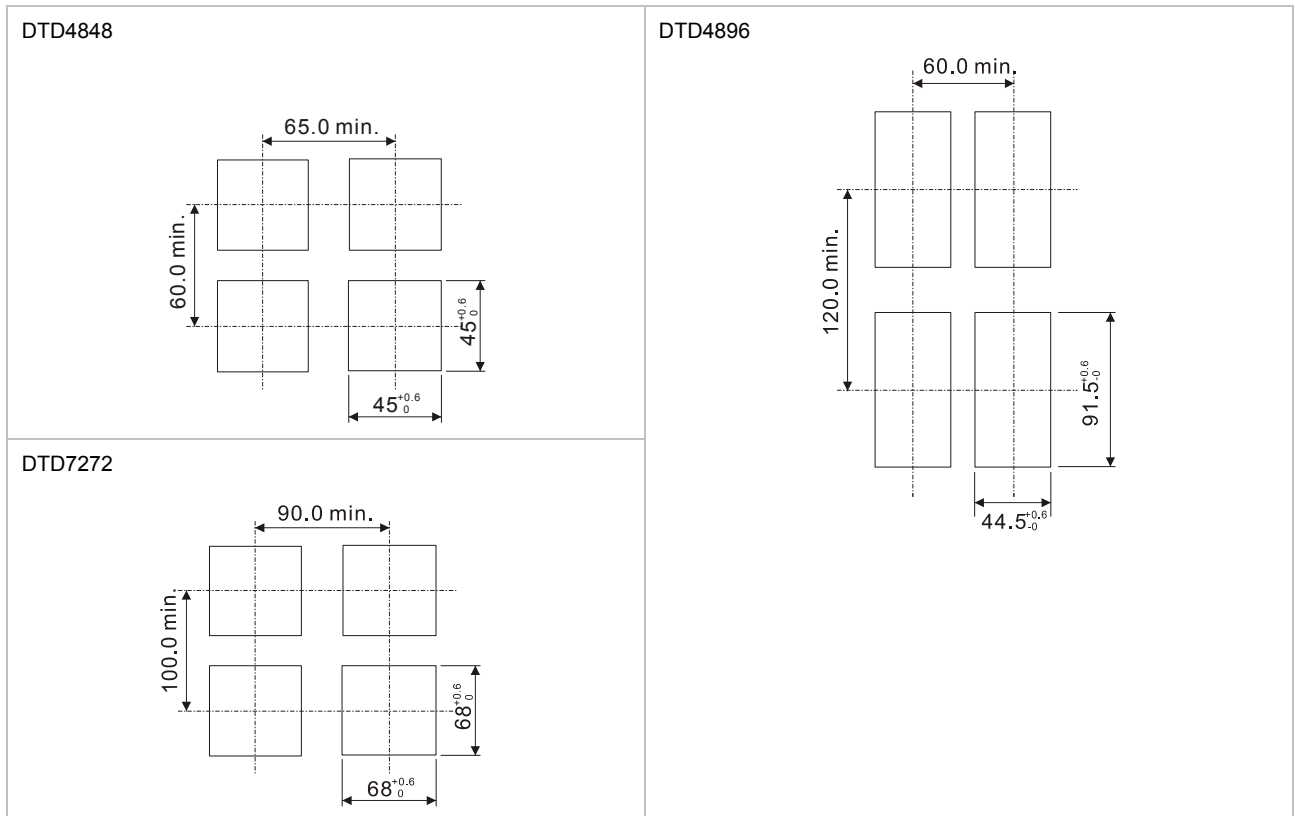

■ Terminals

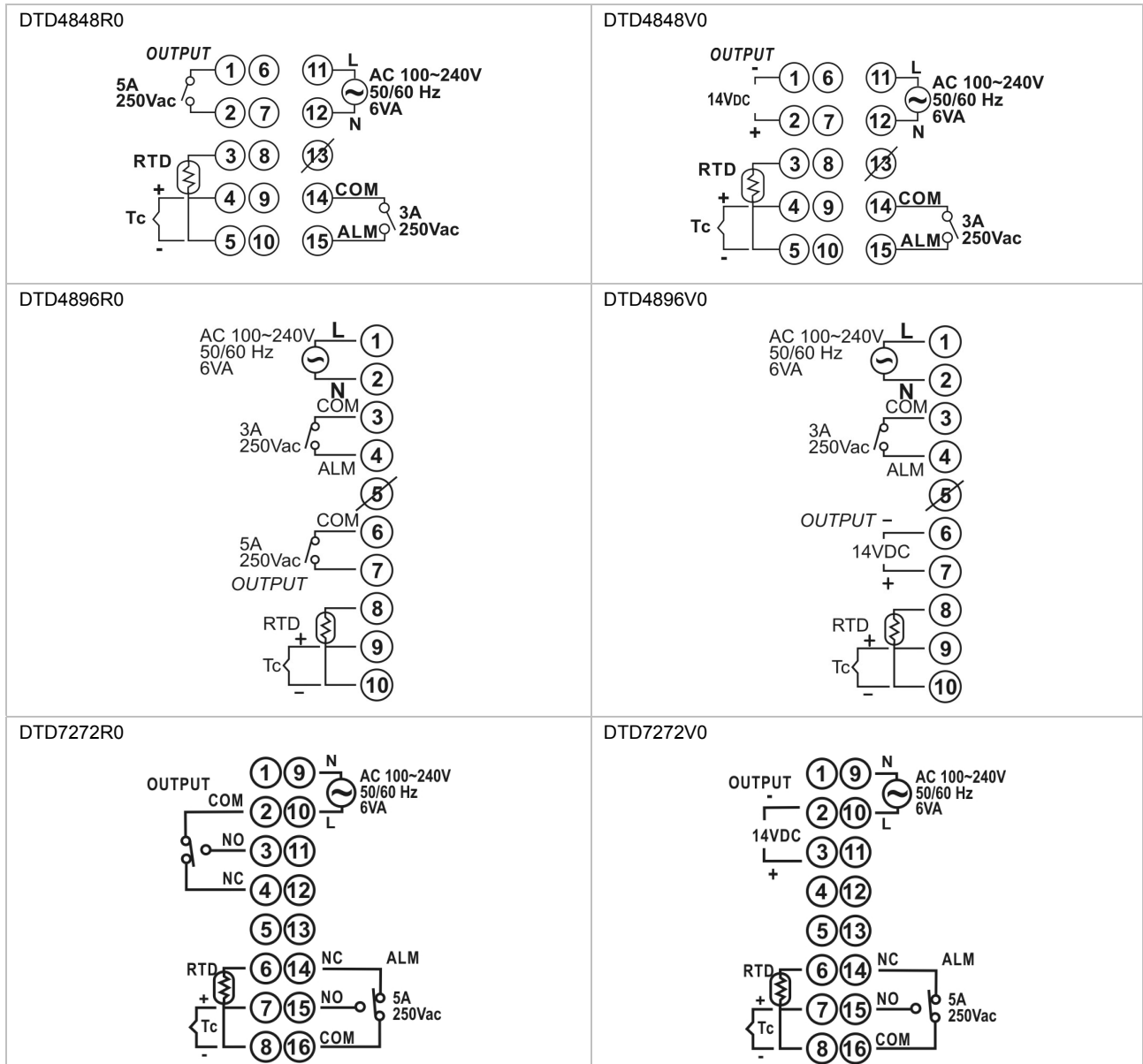

■ How to Set Up Current Input

Please connect a 249Ω resistor between the terminals TC+ and TC- in parallel.

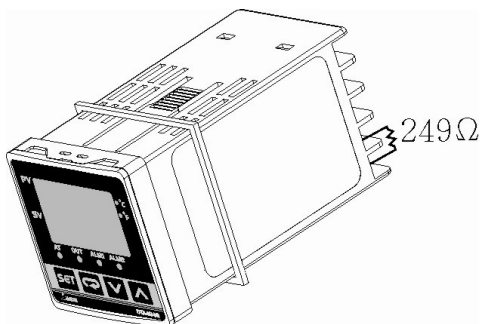

The content of this instruction sheet may be revised without prior notice. Please consult our distributors or download the most updated version at <http://www.delta.com.tw/industrialautomation>